

ARTICOLO - IP44-E27-1



Made in Italy
MOSAIC S.p.A.
Lungo Dora P. Colletta n.113/9
10153 - Torino (TO) ITALY
www.creative-cables.com

1xMAX 12 W E27

220-240 V

Cl. II IP44*

SE IL CAVO FLESSIBILE ESTERNO DI QUESTO APPARECCHIO VIENE DANNEGGIATO DEVE ESSERE SOSTITUITO DAL COSTRUTTORE O DAL SUO SERVIZIO ASSISTENZA O DA PERSONALE QUALIFICATO EQUIVALENTE AL FINE DI EVITARE PERICOLI

IF THE EXTERNAL FLEXIBLE CABLE OF THIS LUMINAIRE IS DAMAGED, IT SHALL BE EXCLUSIVELY REPLACED BY THE MANUFACTURER OR HIS SERVICE AGENT OR A SIMILAR QUALIFIED PERSON IN ORDER TO AVOID HAZARDS

UNBOXING

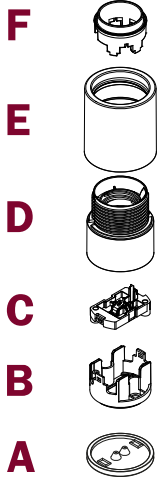

G x2

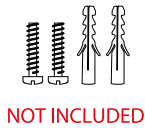

1

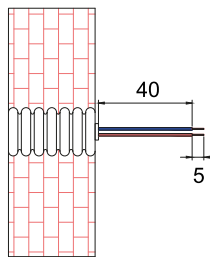
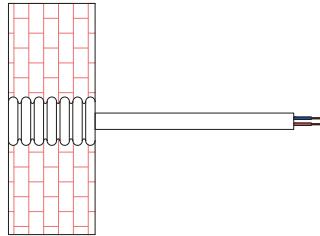
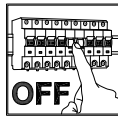

2

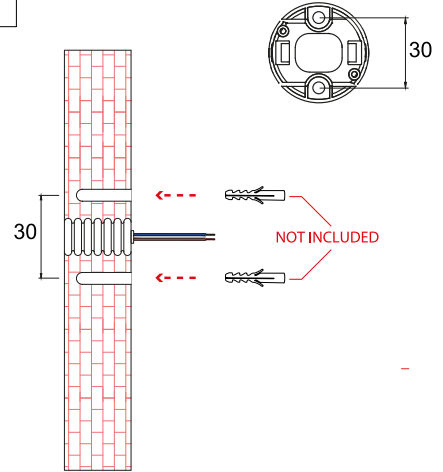

3

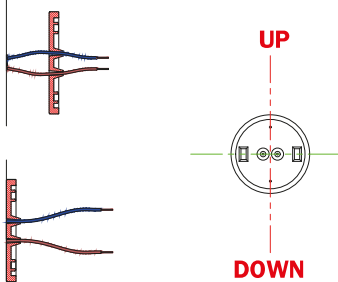
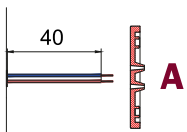

4

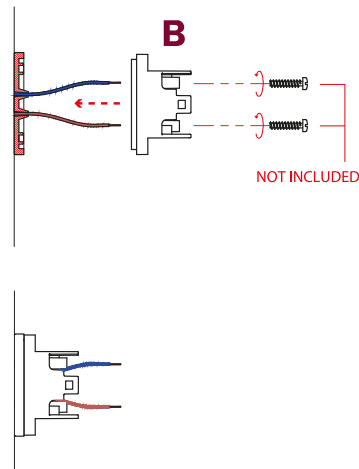

5

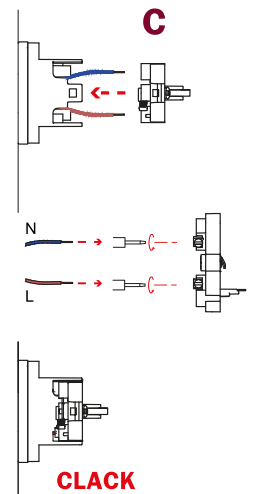

6

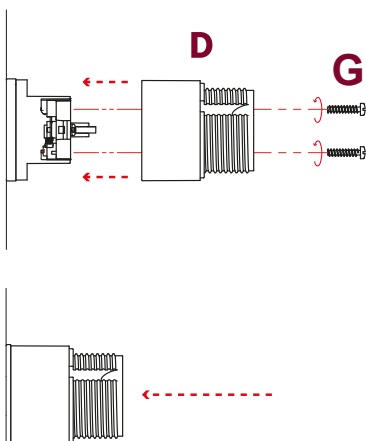

7

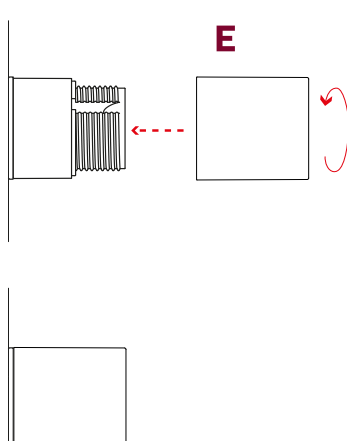

8

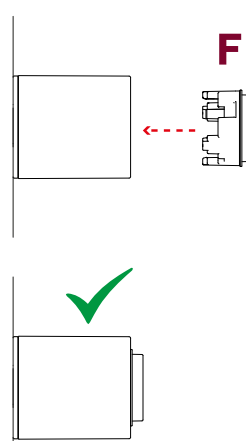

9

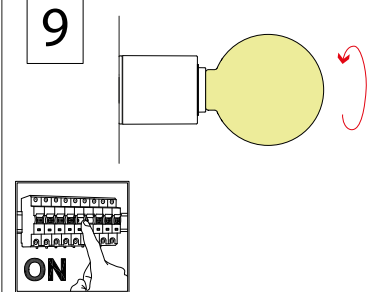

*** WARNING**

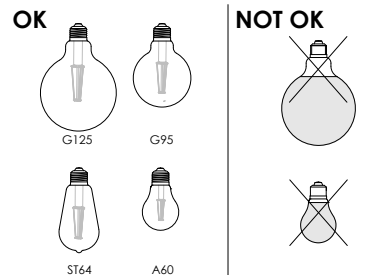

ARTICOLO - IP44-E27-2



Made in Italy
MOSAIC S.p.A.
Lungo Dora P.Colletta n.113/9
10153 - Torino (TO) ITALY
www.creative-cables.com

1xMAX 12 W E27

220-240 V

Cl. II IP44*

SE IL CAVO FLESSIBILE ESTERNO DI QUESTO APPARECCHIO VIENE DANNEGGIATO DEVE ESSERE SOSTITUITO DAL COSTRUTTORE O DAL SUO SERVIZIO ASSISTENZA O DA PERSONALE QUALIFICATO EQUIVALENTE AL FINE DI EVITARE PERICOLI

IF THE EXTERNAL FLEXIBLE CABLE OF THIS LUMINAIRE IS DAMAGED, IT SHALL BE EXCLUSIVELY REPLACED BY THE MANUFACTURER OR HIS SERVICE AGENT OR A SIMILAR QUALIFIED PERSON IN ORDER TO AVOID HAZARDS

UNBOXING

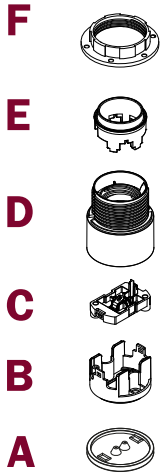

G x2

